

# THYRISTORS AND TRIACS, AN IMPORTANT PARAMETER : THE HOLDING CURRENT

By E. LEBLANC

The purpose of this note is to familiarize the user of a triac (or a thyristor) with the parameter  $I_H$  : hypostatic current or holding current.

After a short definition, we will illustrate the importance of this parameter by concrete examples. Then we will describe how to measure it and finally its variation with the conditions of use and the sensitivity of the components.

In all cases we speak of triacs. However, the statements are also valid for thyristors.

## DEFINITION

To keep an electromagnetic relay in the conducting state, it is necessary for a minimum current to circulate in its coil. Otherwise it would return to the blocked state. The same phenomenon can be observed for a triac. This minimum current which keeps the triac conducting is called the hypostatic or holding current (figure 1).

**Figure 1** : Controlled by gate pulse  $I_G$ , the triac is fired and a current  $I_T$  flows through it, fixed by the main circuit. When the current  $I_T$  falls below the triac hypostatic current  $I_H$ , it is reblocked.

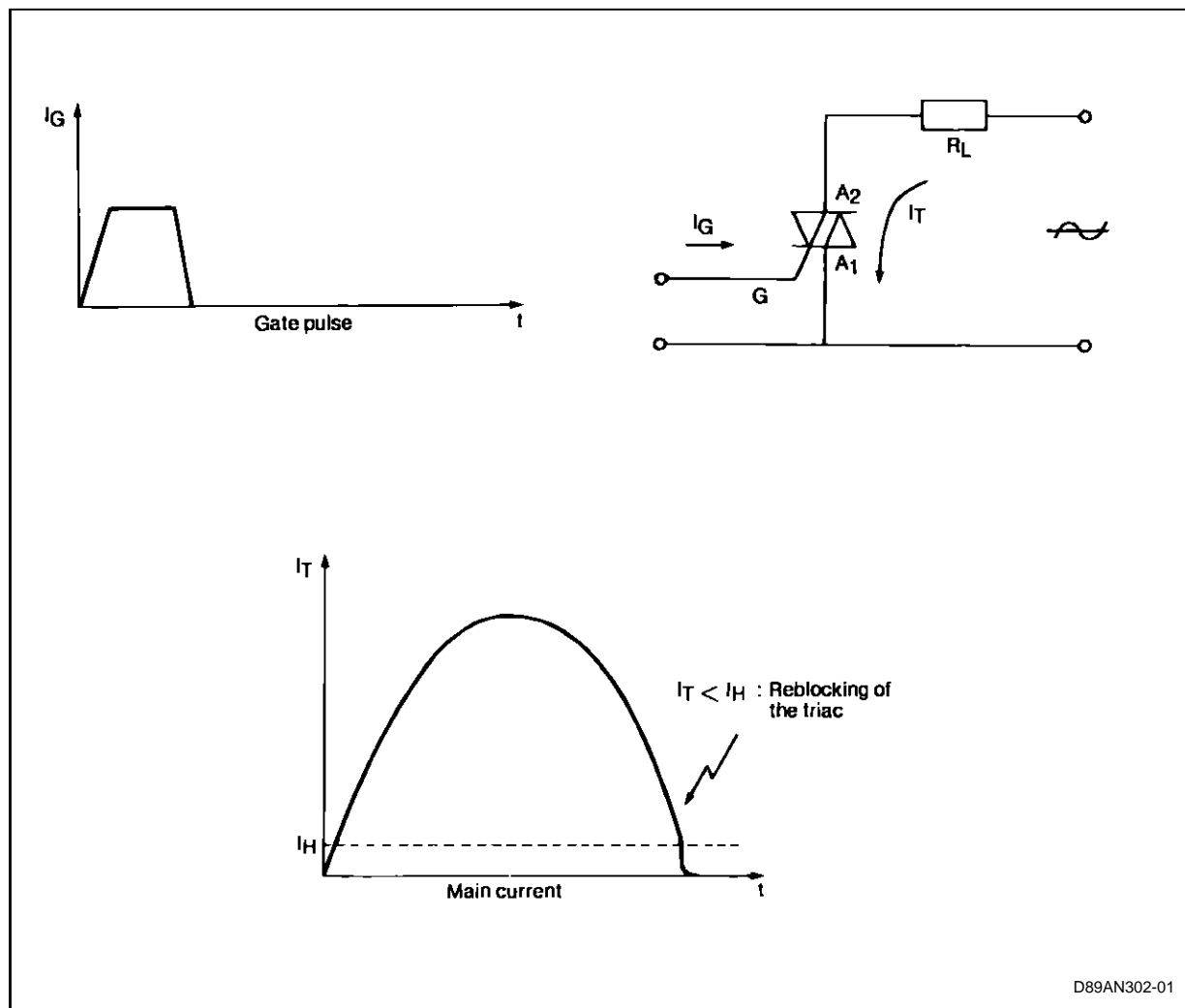

D89AN302-01

APPLICATIONS

Example 1 : Light dimmer (figure 2).

Figure 2 : Dimmer with Interface Suppression Coil and Capacitor (RFI filter).

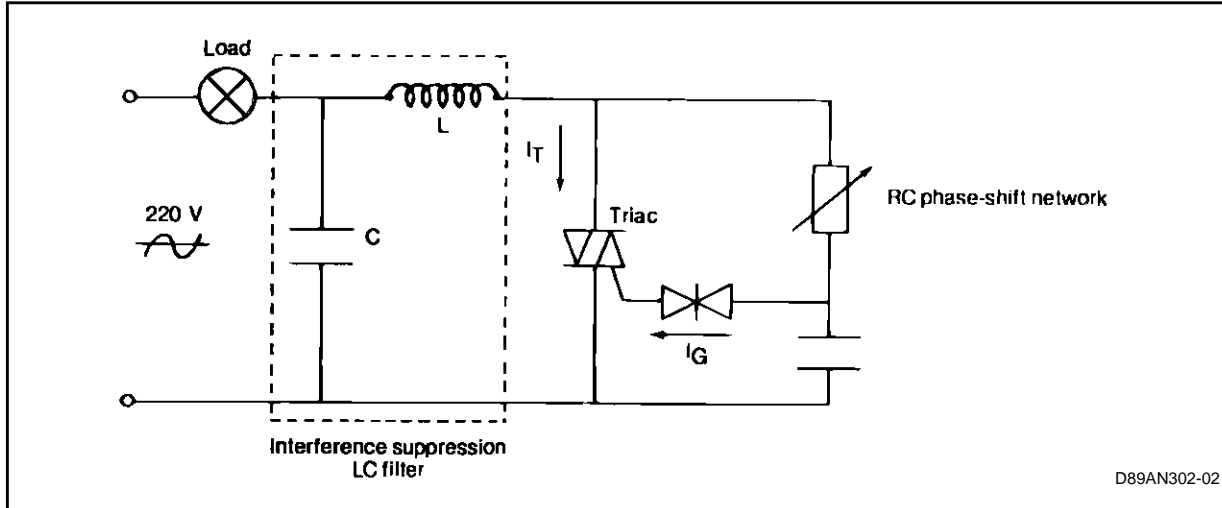
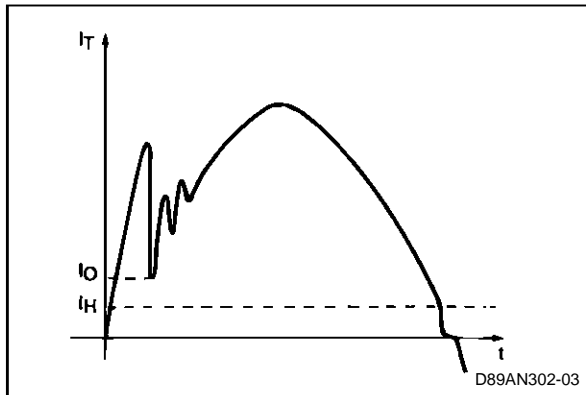

Figure 3 : Current in the dimmer triac :  
The interference suppression filter produces oscillations. If  $I_0 > I_H$  (as in the figure) the triac remains fired. But if  $I_0$  falls below  $I_H$ , the triac will be blocked.



If the coil is a poor quality one, the oscillation is insufficiently damped. If the current in the triac falls below the hypostatic current,  $I_H$ , this results in untimely blocking of the triac. It is fired at the next current pulse  $I_G$  and is blocked again. The lamp flickers. This is known as the "flicker effect".

How can it be prevented ? By eliminating the cause, i.e. using an appropriate interference suppression filter which does not produce extensive oscillations, and then by choosing a triac with a lower hypostatic current  $I_H$ .

SGS-THOMSON Microelectronics has developed a triac specially designed for applications where a low hypostatic current  $I_H$  is required, the BTA 06 400 GP.

This device is specified with a maximum holding current  $I_H$  of 13mA in both current flow directions.

Example 2 : Motor Control (figure 4).

Figure 4 : Control of a Small Motor by Triac.

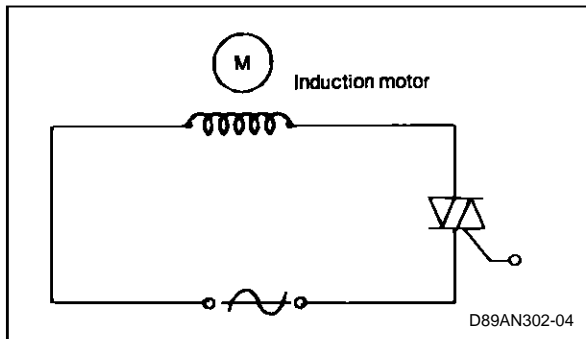

The designer wishes to control a small high-impedance motor (2500ohms for example) by triac. He obtains the parts and an operating manual and carries out tests. The circuit operates smoothly. After one year of production, the manufacturer complains of low torque in his motor and blames the triac. What's happened ?

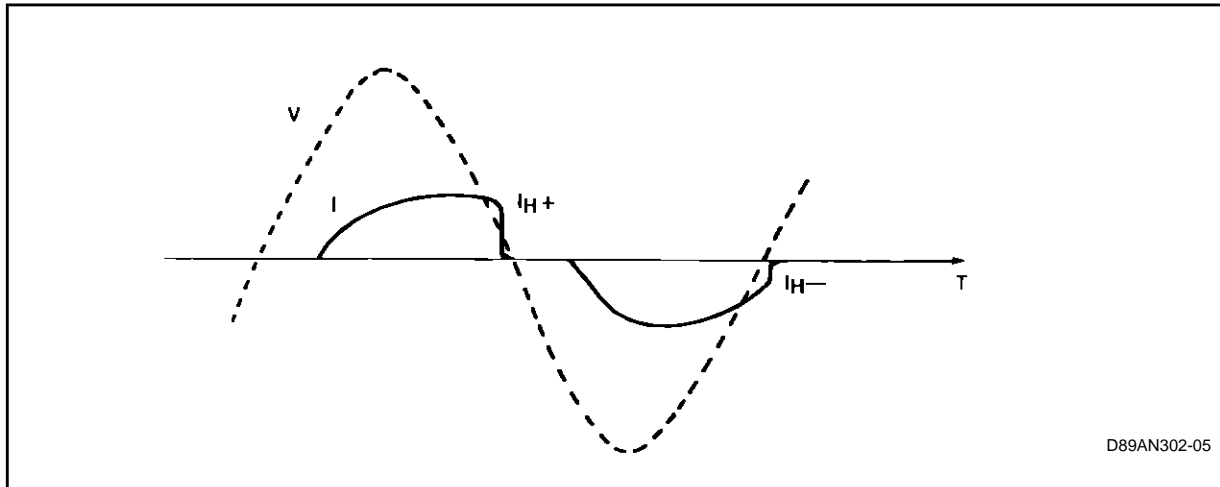
**Figure 5** : Voltage Across the Triac and Current in the Circuit of Figure 4.

The circuit was designed with a type of triac whose maximum specified holding current  $I_H$  was 50mA. But the components used for the tests were more sensitive :  $I_{H+} = 13\text{mA}$  and  $I_{H-} = 8\text{mA}$  and the designer based his choice on these results. After a year of delivery, the component manufacturer continues to deliver parts which are in conformity with the specification but less sensitive :  $I_{H+} = 40\text{mA}$  and  $I_{H-} = 20\text{mA}$ . The conduction time decreases (*figure 5*), the dissymmetry is greater, a DC component appears and the motor loses torque.

To prevent this kind of difficulty, when designing the circuit it is thus necessary to take into account not the typical value of the sample used but the maximum value specified by the component manufacturer.

### Example 3 :

Take the diagram of the previous example (*figure 4*), the control of a small high-impedance motor by triac.

This time, the designer selects a triac with a lower maximum specified holding current,  $I_H$ . The motor seems to operate without problems. The motor is meant for mounting on out-door equipment. The equipment is installed in summer and works well. But in winter, the fault described above occurs. What has happened ? The designer studied the operation of his circuit at an ambient temperature of 25°C. But the holding current  $I_H$  varies with the temperature : when the temperature decreases, the holding current increases (we will study this variation in paragraph 4.6) and the phenomenon described in example 2 occurs.

Thus when designing a circuit which is to operate at low temperatures, it is essential to take into account the corrected value of the holding current and not its value at an ambient temperature of 25°C.

These three examples illustrate the importance of this parameter and the different problems it can cause in a circuit if it is insufficiently known.

If the device is to remain in the conducting state, it is imperative that the circuit in which it is used ensures a current higher than the holding current  $I_H$  of the device.

In our data sheets, for all the types of triacs, the hypostatic current  $I_H$  is specified as a maximum value. A suitable triac should then be chosen whose holding current  $I_H$  is lower than the minimum value of the current in the circuit, if the triac is to remain in the conducting state ; make the necessary corrections to compensate for temperature variations.

### MEASUREMENT OF THE HYPOSTATIC CURRENT $I_H$

Pushbutton P is used to fire the triac. The value of current  $I_T$  is chosen much higher than the latching current. By increasing the value of the variable resistor R, current  $I_T$  will decrease. The value of the hypostatic current  $I_H$  is the value of  $I_T$  read just before the triac is blocked.

The hypostatic current  $I_H$  is always measured with the gate unconnected, i.e. disconnected from the trigger circuit. Only sensitive thyristors ( $I_{GT} \leq 500\mu\text{A}$ ) are measured with a 1kohm resistor connected between gate and cathode.

For the measurement to be regularly repeatable, the triac should be suitably fired. The following rules should be observed :

- Before decreasing current  $I_T$ , it should be equal to at least 5 times the triac  $I_L$  current.

**Example :** BTA 12 600C

$I_L$  typ (QI and III) = 20mA thus  $I_T = 500mA$ .

- if the  $I_H$  current is measured by pulses (automatic testers, for example), the triac should consult for at least 500µs before performing the measurement.

For a triac, the  $I_H$  current has two values : ( $I_H +$ ) when electrode A2 is positive with respect to electrode A1 and ( $I_H -$ ) when electrode A2 is negative with respect to electrode A1. In the documentation only one value is given for both quadrants. This value is always the maximum value.

**Example :** BTA 12 600C :  $I_{H\ max} = 25mA$ .

Depending on the production batch,  $I_H$  can vary. However, the dispersion remains below the limits specified in the catalogue.

To give an idea of this dispersion :

- Sensitive triacs :  $I_{GT}$  (QI) 5mA (type T) :  $2mA \leq I_H \leq 8mA$  (Specified  $I_{H\ max} : 15mA$ ).
- Standard triacs :  $I_{GT}$  (QI) 50mA (type B) :  $8mA \leq I_H \leq 40mA$  (Specified  $I_{H\ max} : 50mA$ ).

**Note :** The minimum value of the  $I_H$  parameter is never specified in the data sheets.

**Figure 6 :** Circuit for Measurement of the Holding Current  $I_H$ .

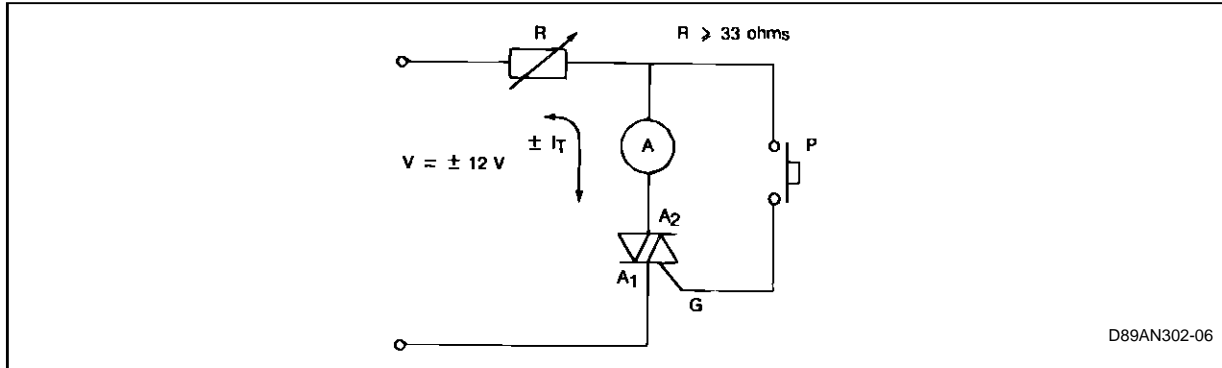

**VARIATION OF THE HOLDING CURRENT,  $I_H$**

**a) Variation of current  $I_H$  with the sensitivity of the devices and the direction of conduction (typical value)**

For low components (thyristors and triacs whose rated current is less than 60A), the hypostatic current,  $I_H$ , is related to the firing current,  $I_{GT}$  (see figure 7).

**Figure 7 :** Ratio between the Holding Current,  $I_H$  (A2 +) and Current  $I_{GT}$  (QI) for Sensitive and Standard Triacs.

	$I_H + / I_{GT}$ (Q1)
Sensitive triac 6 A <sub>rms</sub> (T type)	3
Standard triac 12 A <sub>rms</sub> (C type)	1.5

**Example 1 :**

BTA 06 600T : if  $I_{GT}$  (QI) = 1.5mA then  $I_H + = 4.5mA$ .

BTA 12 600C : if  $I_{GT}$  (QI) = 10mA then  $I_H = 15mA$ .

In the case of the triac (as distinguished from the thyristor) it is important to note that current  $I_H -$  (electrode A2 negative with respect to A1) is generally lower than  $I_H +$  (see figure 8).

**Figure 8 :** Ratio between Holding Current  $I_H +$  (A2 +) and Holding Current  $I_H -$  (A2 -) for Sensitive and Standard Triacs.

	$I_H + / I_H -$
Sensitive triac 6 A <sub>rms</sub> (T type)	1.2
Standard triac 12 A <sub>rms</sub> (C type)	1.2

**Example 2 :**

BTA 06 600T : if  $I_H + = 4.3mA$ ,  $I_H - = 3.8mA$ .

BTA 12 600B : if  $I_H + = 15mA$ ,  $I_H - = 12.5mA$ .

**b) Variation of the hypostatic current,  $I_H$ , with the junction temperature :**

The value of the hypostatic current is physically related to that of the firing current,  $I_{GT}$ . These two parameters thus vary with the junction temperature in accordance with an analog law (see figure 9).

**Example :** Triac TO 220, type BTA 12 600C  
 $I_H = 20\text{mA}$  at  $T_j = 25^\circ\text{C}$ ,  
 thus  $I_H = 14\text{mA}$  at  $T_j = 110^\circ\text{C}$ .

**Figure 9 :** Relative Variation of the Holding Current  $I_H$ , with the Junction Temperature,  $T_j$  (typical values).

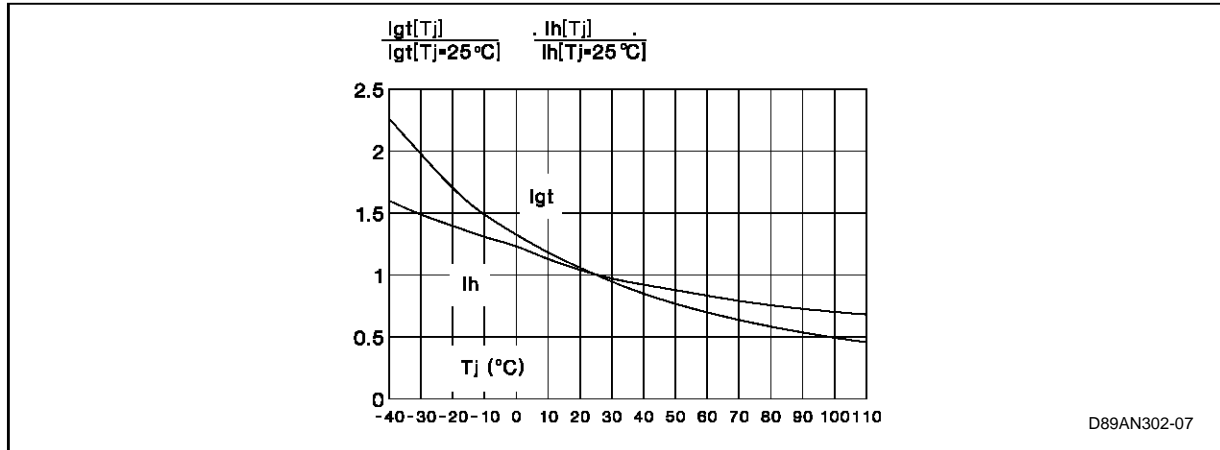

**c) Influence of the reapplied voltage :**

The rise time and the level of the reapplied reverse voltage across the triac after blocking have no influence on the value of its holding current,  $I_H$ .

sensitive thyristors, or because it forms part of the firing circuit. This resistor has an influence on the holding current,  $I_H$ , in different proportions depending on its resistive value and the sensitivity of the components :

**d) Influence of the external gate cathode resistor,  $R_{GK}$**

The user can wire a resistor,  $R_{GK}$ , between the gate and the cathode of the component, either to improve its behaviour under voltage at high junction temperatures (by-pass for leakage current) in the case of

1 - Sensitive thyristors ( $I_{GT} \leq 500\mu\text{A}$ )

Resistor  $R_{GK}$  connected between the gate and the cathode (figure 10) has an important influence on the  $I_H$  parameter of sensitive thyristors. For certain applications, the designer would be well-advised to define a high impedance control circuit.

**Figure 10 :** Variation of the Hypostatic Current,  $I_H$ , of a Sensitive Thyristor (e. g. TLS 106-6) as a Function of the Gate-cathode Resistor (typical values).

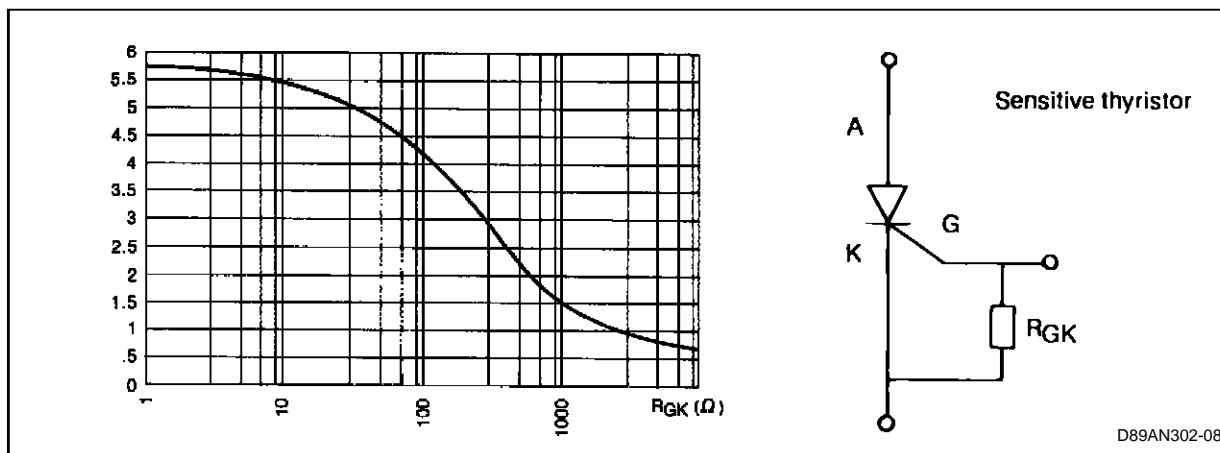

**Note :** The hypostatic current for sensitive thyristors is always specified for  $R_{GK} = 1000\text{ohms}$ .

## APPLICATION NOTE

2 - Standard thyristors, sensitive and standard triacs

A resistor between gate and cathode on one of these components has no significant influence on the value of its holding current,  $I_H$  (on condition that it is not too low,  $R_{GC} > 20\text{ohms}$ ).

### e) Note :

We have seen that the more sensitive the triac (Low  $I_G$ ), the lower the value of the holding current,  $I_H$ .

Now, in certain applications, a sensitive triac (direct control by integrated circuit) with a high  $I_H$  (or  $I_L$ ) may be useful.

In this case, the circuit of *figure 11* could be used. The assembly is sensitive but has a higher hypostatic current.

**Figure 11 :** This Component, a «DARLINGTON TRIAC» combines a High Sensitivity with a High Hypostatic Current.

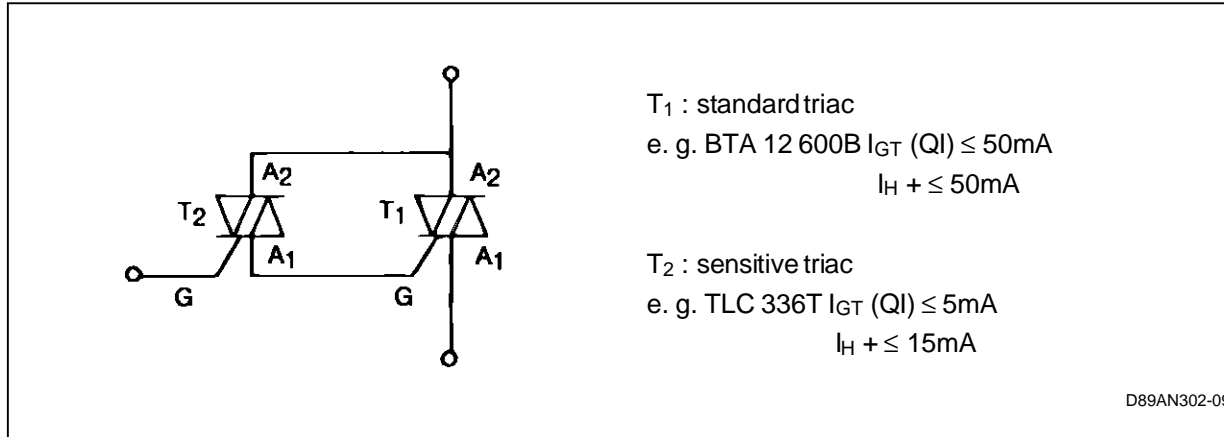

## CONCLUSION

The choice of a thyristor or a triac does not depend only on the voltage, the rated current and the sensitivity. Other parameters should be taken into account.

The hypostatic current,  $I_H$  plays an important role in many circuits.

The value of this parameter varies with :

- dispersion of characteristics at manufacture,
- temperature,
- eventually the control circuit (in the case of sensitive thyristors),
- the direction of current flow.

Taking into account these elements, the designer can obtain satisfactory operation of his circuit in industrial real life applications.

Knowing the problems which could be created by this parameter, SGS-THOMSON Microelectronics has introduced a new triac, BTA 06 400 GP, now available for the designers. Its low holding current, specified with a maximum value, enables it to be used in most applications.

Information furnished is believed to be accurate and reliable. However, SGS-THOMSON Microelectronics assumes no responsibility for the consequences of use of such information nor for any infringement of patents or other rights of third parties which may result from its use. No license is granted by implication or otherwise under any patent or patent rights of SGS-THOMSON Microelectronics. Specifications mentioned in this publication are subject to change without notice. This publication supersedes and replaces all information previously supplied.

SGS-THOMSON Microelectronics products are not authorized for use as critical components in life support devices or systems without express written approval of SGS-THOMSON Microelectronics.

© 1995 SGS-THOMSON Microelectronics - Printed in Italy - All rights reserved.

SGS-THOMSON Microelectronics GROUP OF COMPANIES

Australia - Brazil - France - Germany - Hong Kong - Italy - Japan - Korea - Malaysia - Malta - Morocco -  
The Netherlands - Singapore - Spain - Sweden - Switzerland - Taiwan - Thailand - United Kingdom - U.S.A.